

















































































Parts

Chassis ID N 257988	Path 8181/Parts/81810-K00194/CAB MOUNTING
Model VN	Identity 81810-K00194

CAB MOUNTING (Identity: 81810-K00194)

A:

Pos	Part No.	A	Description	Notes		
0005	8078546	2	ABSORBER, SHOCK			
0010	8078547	2	ABSORBER, SHOCK, HORIZONTAL			
0015	8078144	1	ANCHORAGE, DUAL LATERAL DAMPER			
0020	8078706	1	ANCHORAGE, DUAL LATERAL DAMPER			
0030	8082968	2	BRACKET ASSEMBLY; BRACKET ASSEMBLY			
0035	8082969	1	BRACKET ASSEMBLY; BRACKET ASSEMBLY			
0040	8075738	1	BRACKET-CAB FRT MTG-LH; BRACKET			
0050	8075739	1	BRACKET-CAB FRT MTG-RH; BRACKET			
0060	8079752	1	BRACKET ASSEMBLY; BRACKET ASSEMBLY			
0075	965557	3	BRACKET-FUSION			
0090	952622	3	CLAMP, 4,8			
0110	8397697	2	FITTING, 6,4*1/8NPTF			
0120	979230	4	FLANGE NUT, M12*19,8			
0125	977938	4	FLANGE LOCK NUT, M12*16,1			
0130	979231	2	FLANGE NUT, M14*22,9			
0135	979231	2	FLANGE NUT, M14*22,9			
0140	979231	2	FLANGE NUT, M14*22,9			
0145	977939	4	FLANGE LOCK NUT, M14*18,2			
0150	977939	4	FLANGE LOCK NUT, M14*18,2			
0155	981040	4	FLANGE LOCK NUT, M14*22,9			
0160	981040	4	FLANGE LOCK NUT, M14*22,9			
0165	946673	2	FLANGE LOCK NUT, M16*20,3			
0170	949278	6	FLANGE LOCK NUT, M6*7,3			
0180	8080175	1	MEMBER			
0195	961996	8	HEXAGON NUT, M20*18			
0205	8076265	2	RETAINER, CLIP			
0230	8076526	1	CONTROL ROD, REAR; CONTROL ROD REAR			
0240	965192	4	FLANGE SCREW			
0255	982387	4	FLANGE SCREW ,M14*40			

Pos	Part No.	A	Description	Notes		
0260	982387	4	FLANGE SCREW ,M14*40			
0245	946473	2	FLANGE SCREW , M12*90			
0265	966366	2	FLANGE SCREW, M14*90			
0270	966367	2	FLANGE SCREW			
0275	966367	2	FLANGE SCREW			
0280	946934	4	FLANGE SCREW, M6*20			
0285	946173	2	CAPSCREW			
0290	959236	2	SCREW-HEX SOCKET M10*20			
0295	971008	2	HEXAGON SCREW, M14*100			
0300	955380	2	SCREW, HEX, M16*160			
0305	963338	8	HEXAGON SCREW,M20*70			
0315	8075457	4	SHIM, FRONT CAB MOUNT			
0325	8074629	2	AIR SPRING, CAB; AIR SPRING, CAB			
0335	8075527	2	BUMP STOP-UPPER			
0350	8079360	3	CABLE TIE, 115			
0340	8078549	2	BUMP STOP; BUMP STOP			
0360	945460	1	TUBE, 6,4*1, BLACK			
0365	945460	1	TUBE, 6,4*1, BLACK			
0370	945460	1	TUBE, 6,4*1, BLACK			
0380	20354493	1	LEVEL VALVE; LEVEL VALVE			
0390	8076271	2	WASHER			
0395	976943	2	WASHER, 6,4*18*2			
0400	955900	3	WASHER, 17*30*3			
0405	948576	1	WASHER-17*36*4			
0410	1075368	16	WASHER,21*36*5,8			

CAB MOUNTING (Identity: 81810-K00194)

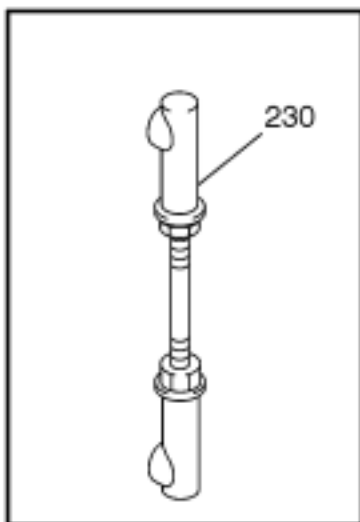
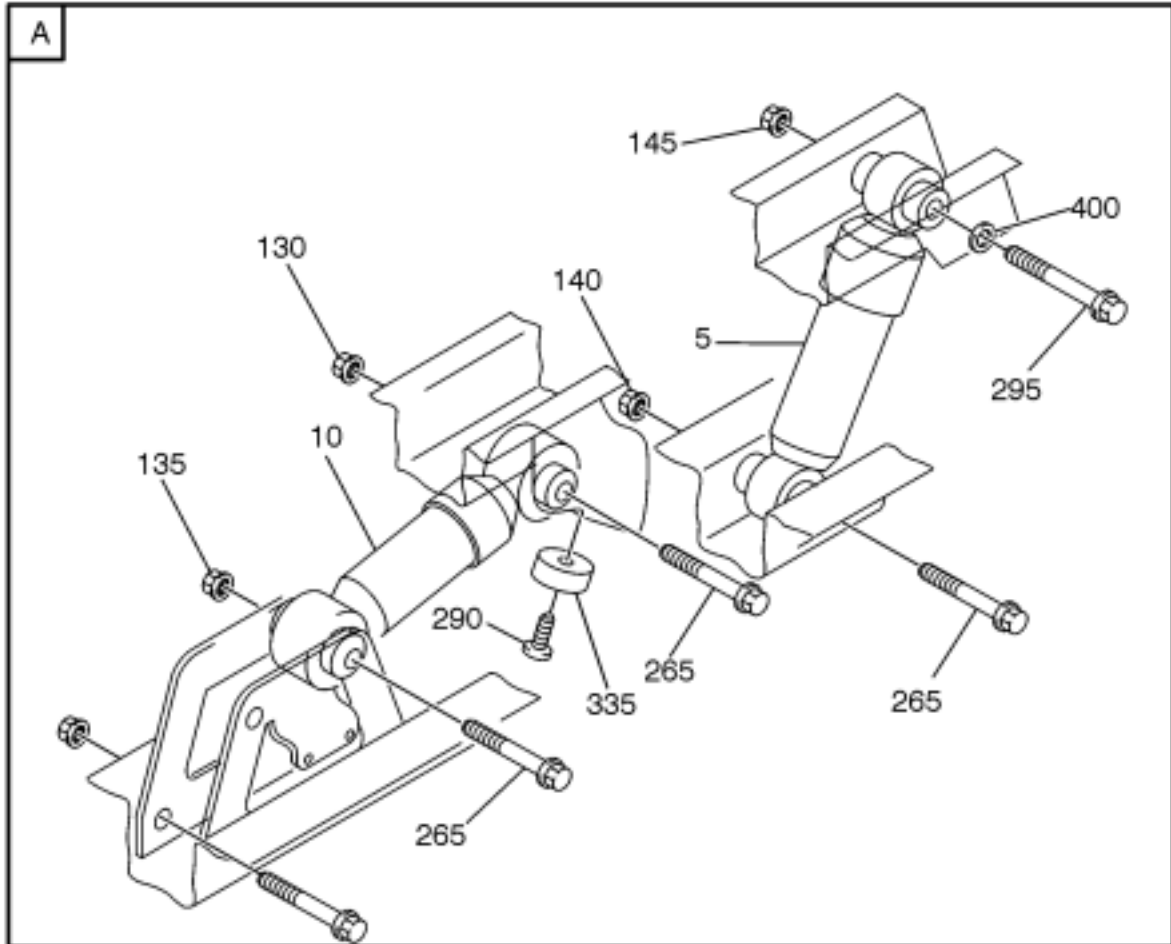

81810-8946
© Volvo Parts Corp

Copyright to this documentation belongs to the Volvo Group. No reproduction, copying, change, amendment or other similar disposal is entitled without prior written consent by the Volvo Group

The information contained herein is current at the time of its original distribution, but is subject to change. The reader is advised that printed copies are uncontrolled.

CAB MOUNTING (Identity: 81810-K00194)

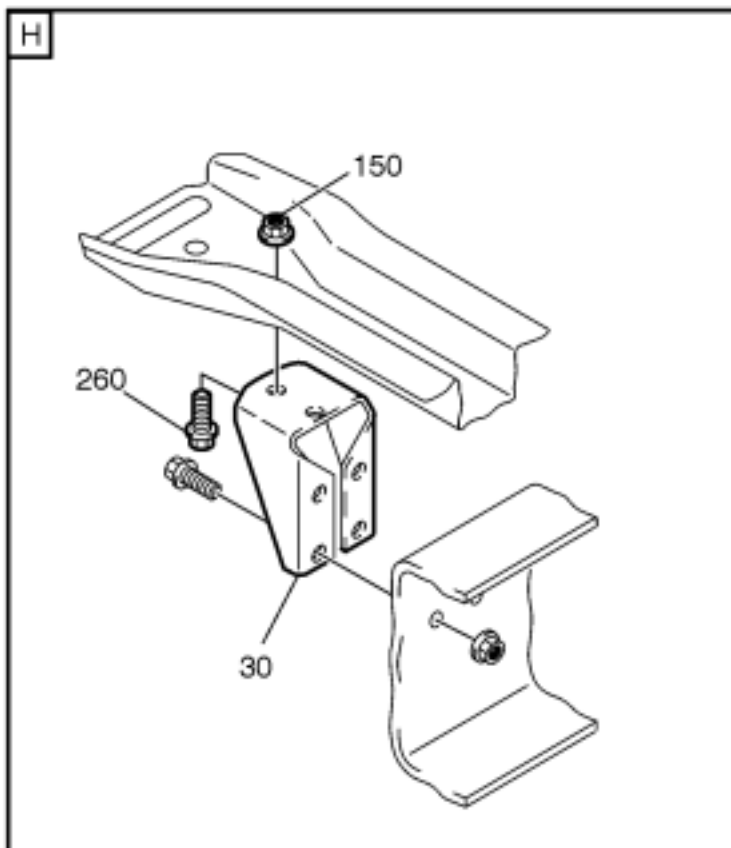
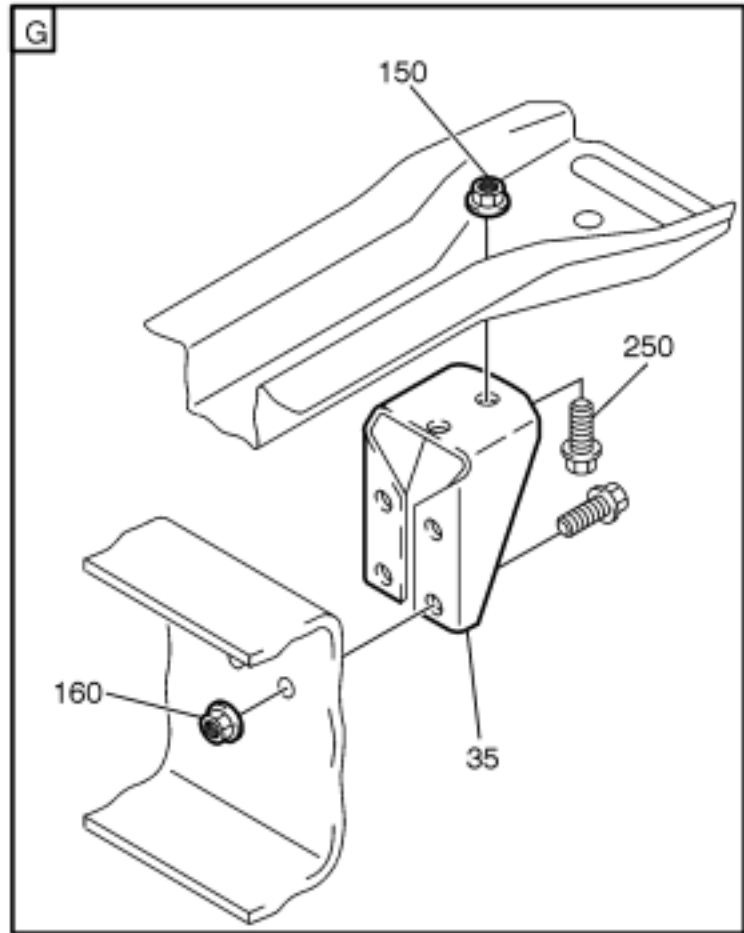

81810-8949
© Volvo Parts Corp

CAB MOUNTING (Identity: 81810-K00194)

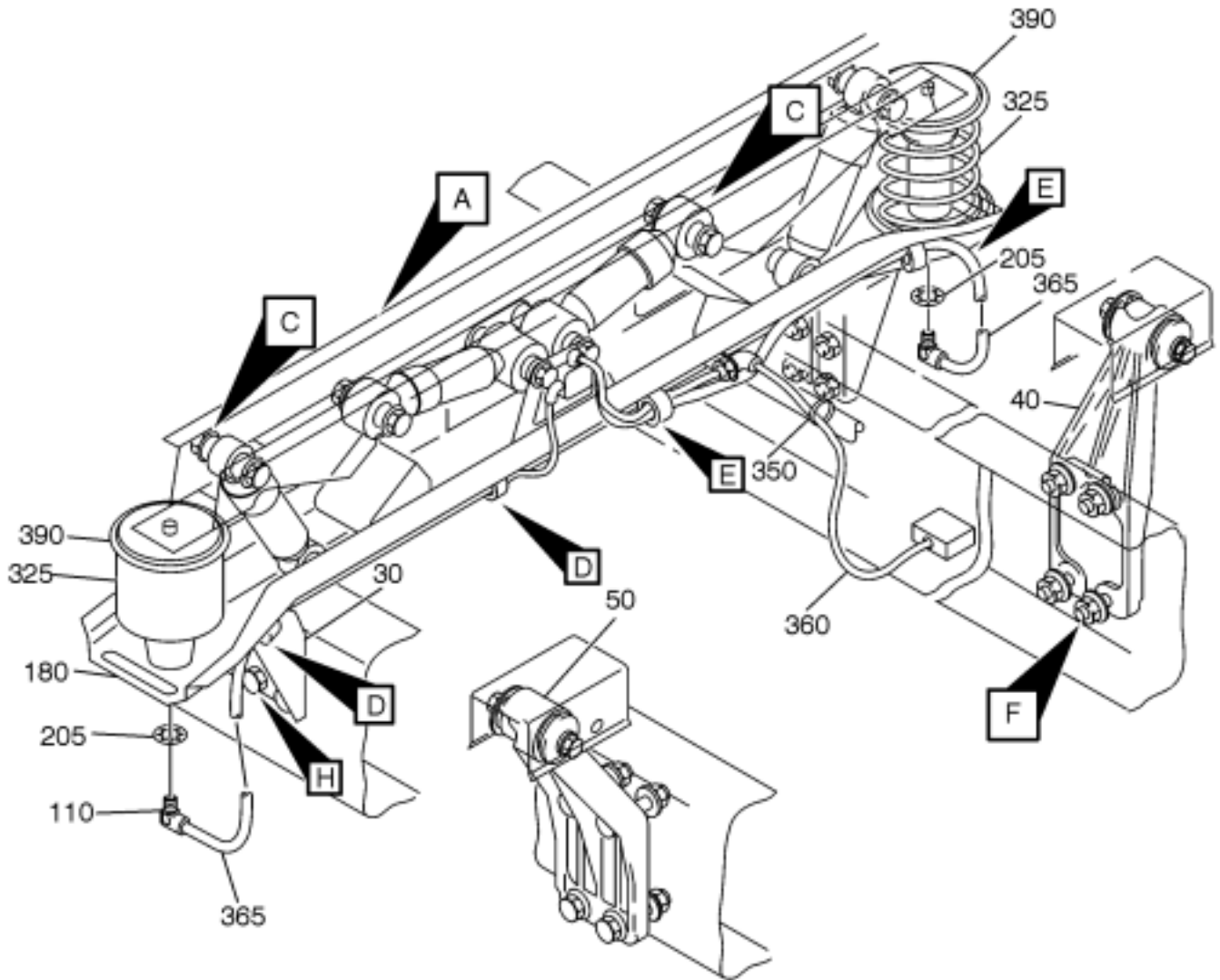
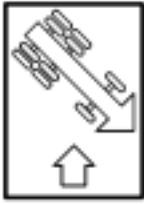

81810-8975
© Volvo Parts Corp

Copyright to this documentation belongs to the Volvo Group. No reproduction, copying, change, amendment or other similar disposal is entitled without prior written consent by the Volvo Group

The information contained herein is current at the time of its original distribution, but is subject to change. The reader is advised that printed copies are uncontrolled.

CAB MOUNTING (Identity: 81810-K00194)

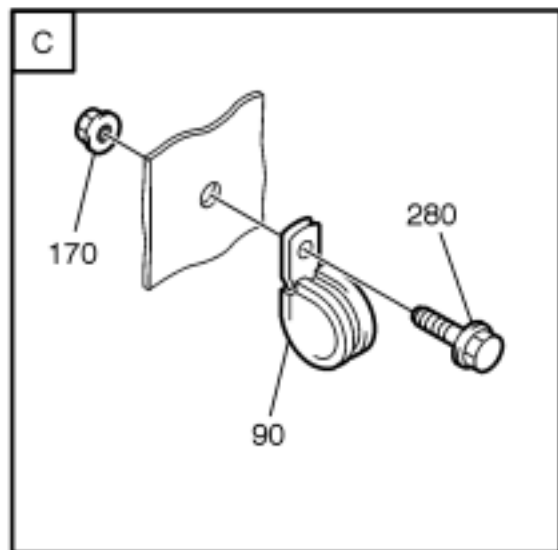
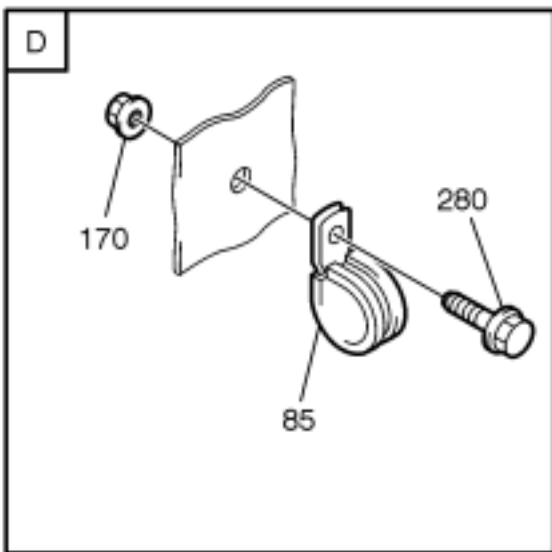
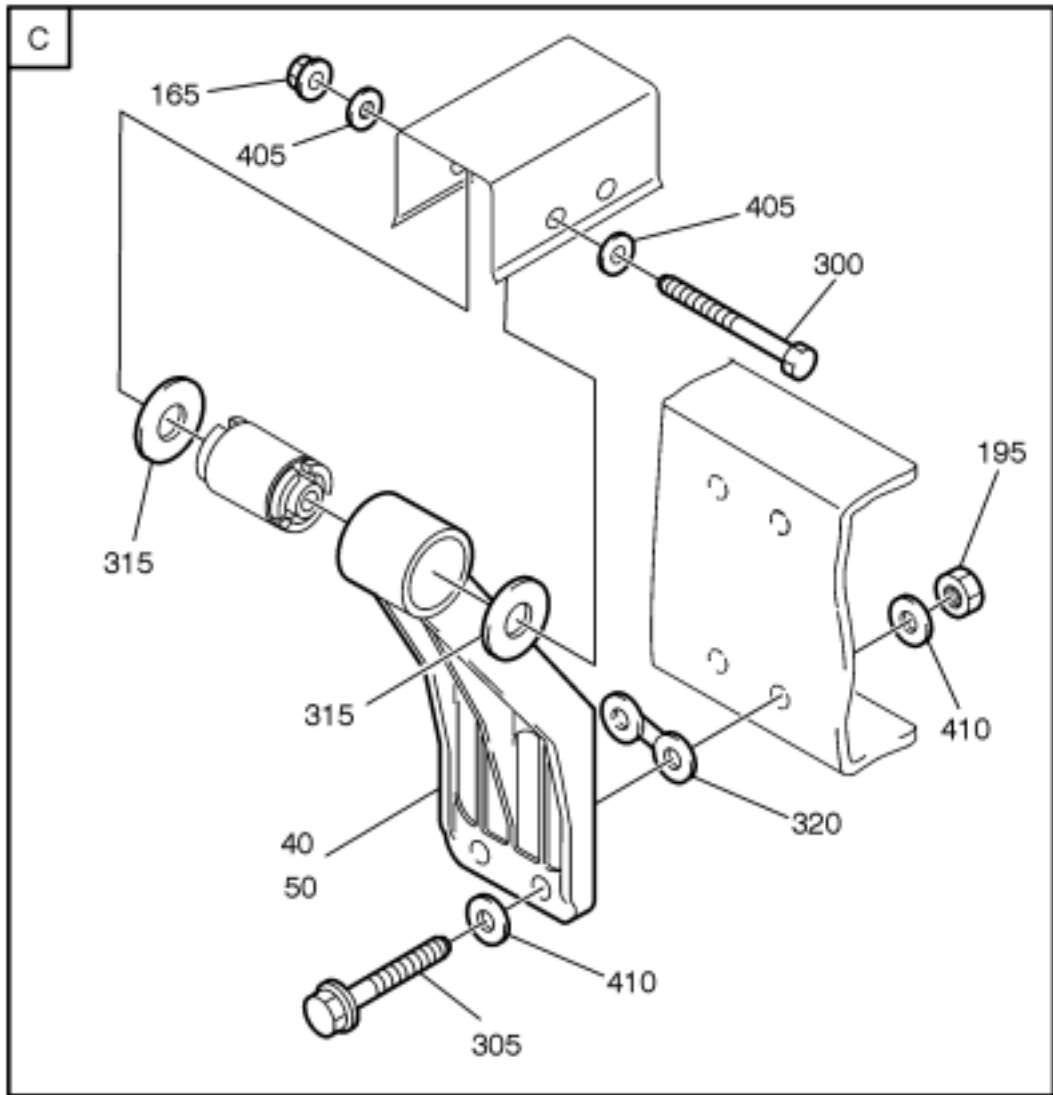

81810-8976
© Volvo Parts Corp

CAB MOUNTING (Identity: 81810-K00194)

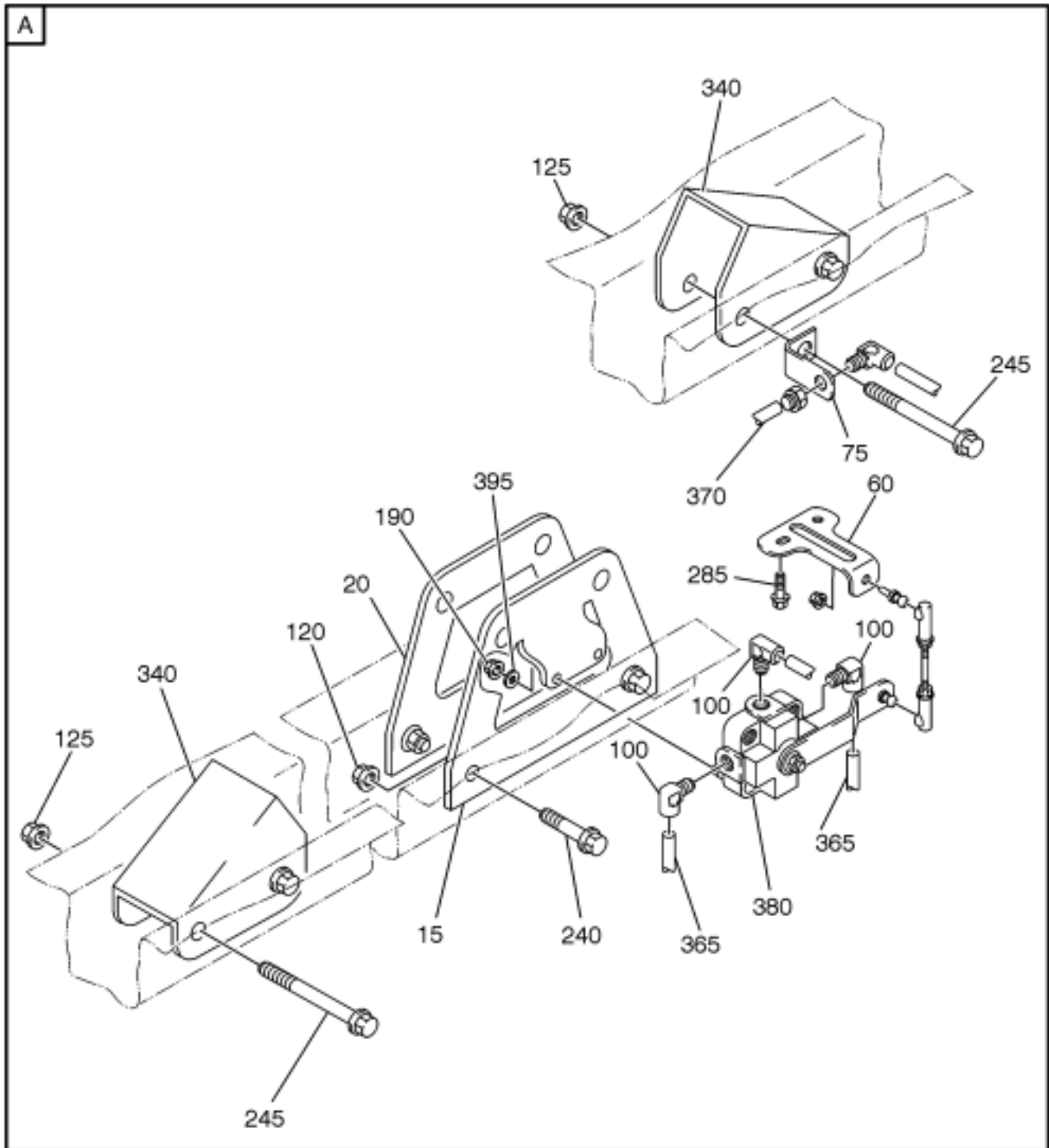

81810-8979
© Volvo Parts Corp

Copyright to this documentation belongs to the Volvo Group. No reproduction, copying, change, amendment or other similar disposal is entitled without prior written consent by the Volvo Group

The information contained herein is current at the time of its original distribution, but is subject to change. The reader is advised that printed copies are uncontrolled.